

## Warranty, Service & Repair

To register your product with the manufacturer, go to the Flowline website for on-line registration. The website address is as follows:

[www.flowline.com](http://www.flowline.com)

On-line Warranty Registration can be found under Contact Flowline on the Navigation Bar along the side of the home page.

If for some reason your product must be returned for factory service, go to the Flowline website listed above. Online Factory Service can be found under Contact Flowline on the Navigation Bar along the side of the home page. Click on **Return Authorization** to begin the registration process. You will need the following information at the time of registration:

1. Part Number and full Serial Number from product
2. Name and telephone number of someone who can answer technical questions related to the product and its application.
3. Return Shipping Address
4. Brief Description of the Symptom
5. Brief Description of the Application

Once you have received a Material Return Authorization number, ship the product prepaid in its original packing to:

Flowline Factory Service  
MRA \_\_\_\_\_  
10500 Humbolt Street  
Los Alamitos, CA 90720

To avoid delays in processing your repair, write the MRA on the shipping label. Please include the information about the malfunction with your product. This information enables our service technicians to process your repair order as quickly as possible.

# FLOWLINE®

## Thermo-Flo™ Flow Switches FT10 and GT10 Series Owner's Manual



Version 0.4A

© 2007 FLOWLINE Inc.

All rights reserved.

Manual # FT900003

09/07

## WARRANTY

Flowline warrants to the original purchaser of its products that such products will be free from defects in material and workmanship under normal use and service for a period which is equal to the shorter of one year from the date of purchase of such products or two years from the date of manufacture of such products.

This warranty covers only those components of the products which are non-moving and not subject to normal wear. Moreover, products which are modified or altered, and electrical cables which are cut to length during installation are not covered by this warranty.

Flowline's obligation under this warranty is solely and exclusively limited to the repair or replacement, at Flowline's option, of the products (or components thereof) which Flowline's examination proves to its satisfaction to be defective. FLOWLINE SHALL HAVE NO OBLIGATION FOR CONSEQUENTIAL DAMAGES TO PERSONAL OR REAL PROPERTY, OR FOR INJURY TO ANY PERSON.

This warranty does not apply to products which have been subject to electrical or chemical damage due to improper use, accident, negligence, abuse or misuse. Abuse shall be assumed when indicated by electrical damage to relays, reed switches or other components. The warranty does not apply to products which are damaged during shipment back to Flowline's factory or designated service center or are returned without the original casing on the products. Moreover, this warranty becomes immediately null and void if anyone other than service personnel authorized by Flowline attempts to repair the defective products.

Products which are thought to be defective must be shipped prepaid and insured to Flowline's factory or a designated service center (the identity and address of which will be provided upon request) within 30 days of the discovery of the defect. Such defective products must be accompanied by proof of the date of purchase.

Flowline further reserves the right to unilaterally waive this warranty and to dispose of any product returned to Flowline where:

- a. There is evidence of a potentially hazardous material present with product.
- b. The product has remained unclaimed at Flowline for longer than 30 days after dutifully requesting disposition of the product.

THERE ARE NO WARRANTIES WHICH EXTEND BEYOND THE DESCRIPTION ON THE FACE OF THIS WARRANTY. This warranty and the obligations and liabilities of Flowline under it are exclusive and instead of, and the original purchaser hereby waives, all other remedies, warranties, guarantees or liabilities, express or implied. EXCLUDED FROM THIS WARRANTY IS THE IMPLIED WARRANTY OF FITNESS OF THE PRODUCTS FOR A PARTICULAR PURPOSE OR USE AND THE IMPLIED WARRANTY OF MERCHANTABILITY OF THE PRODUCTS.

This warranty may not be extended, altered or varied except by a written instrument signed by a duly-authorized officer of Flowline, Inc.

# SPECIFICATIONS

## Step One

### Common Specifications:

Set point range:	FT10: .04 to 3 fps (.012 to .91 mps)
	GT10: 1 to 90 fps (.3 to 27 mps)
Factory set point:	FT10: .2 fps (.06 mps)
	GT10: 10 fps (3 mps)
Repeatability:	±.5% of set point @ fixed temp.
Response time:	1-10 seconds
Set point adjust.:	Potentiometer
Viscosity range:	1-200 centipoise (FT10 only)
Supply voltage:	12-36 VDC
Consumption:	70 mA maximum
Contact type:	(1) SPST relay
Contact rating:	60 VA
Contact output:	Selectable NO/NC
Process temp.:	F: 32° to 140° C: 0° to 60°
Electronics temp.:	F: -40° to 140° C: -40° to 60°
Pressure:	150 psi (10 bar) @ 25° C., derated @ 1.667 psi (.113 bar) per °C. above 25° C.
Sensor rating:	NEMA 4X (IP65)
Sensor material:	1__5: PP-Ryton® 5__5: PVDF Kynar®
Cable jacket mat.:	1__5: PP 5__5: FEP Teflon®
Cable type:	4-conductor, #22 AWG (shielded)
Cable length:	Standard: 10' (3m) Special order: 25' (7.6m) or 50' (15.2m)
Process mount:	3/4" NPT (3/4" G / R)
Mount. gasket:	Viton® (G version only)
Classification:	General purpose
CE compliance:	EN 61326 EMC EN 61010-1 safety

### Thermo-Flo Ultrasonic Level Switch, FT10 Series

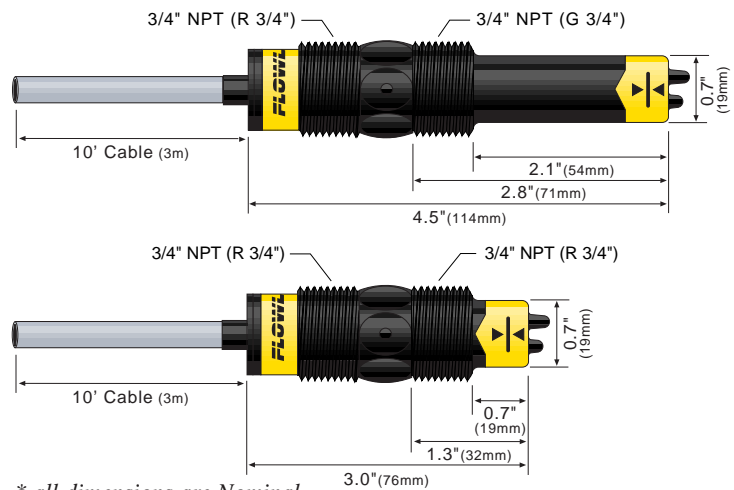

\* all dimensions are Nominal

### Set Points:

The FT10 liquid flow switch set point is factory calibrated to 0.2 fps and the GT10 gas flow switch is set to 10 fps. To convert feet/sec to GPM, please refer to the chart below.

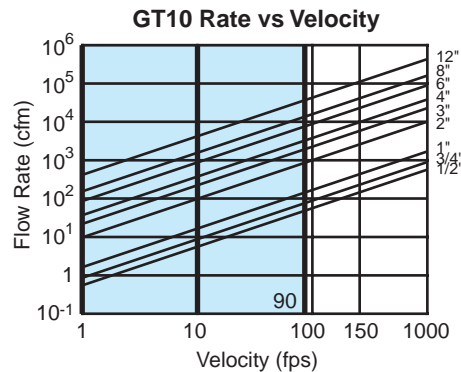
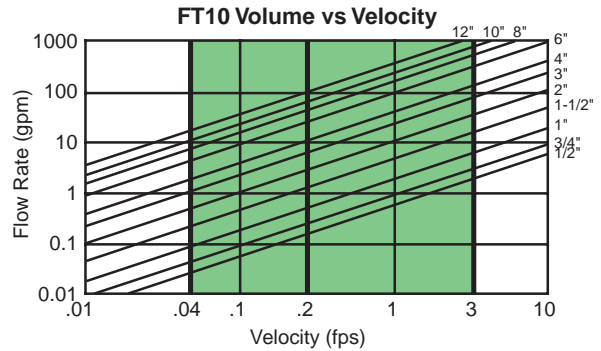

Thermo-Flo Switch	
Medium	T10 - 5
F - Liquid	
G - Gas	
Sensor Material	
1 - PP	
5 - PVDF	
Sensor Length	
3 - Short	
4 - Long	
Mounting Thread	
0 - 3/4" NPT	
2 - 3/4" ISO	

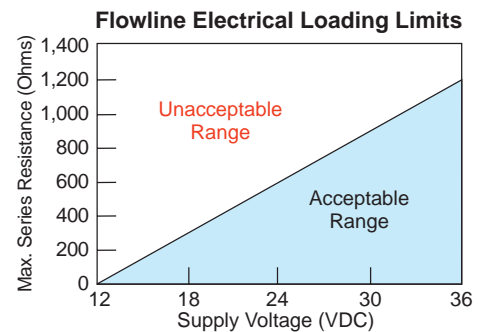
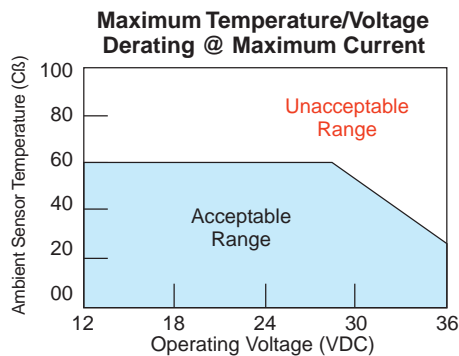
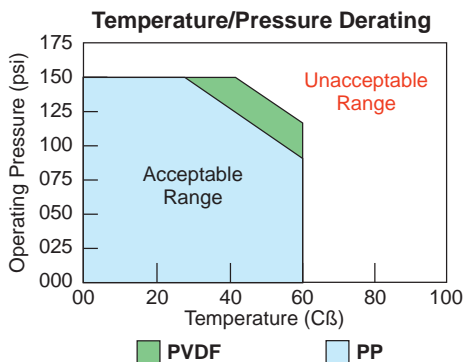

## SAFETY PRECAUTIONS

### Step Two

#### **About this Manual:**

PLEASE READ THE ENTIRE MANUAL PRIOR TO INSTALLING OR USING THIS PRODUCT. This manual includes information on all models of Flowline Thermo-Flo Flow Switches: FT10 and GT10 series. Please refer to the part number located on the switch label to verify the exact model which you have purchased.

#### **User's Responsibility for Safety:**

Flowline manufactures a wide range of flow switches and technologies. While each of these sensors is designed to operate in a wide variety of applications, it is the user's responsibility to select a sensor model that is appropriate for the application, install it properly, perform tests of the installed system, and maintain all components. The failure to do so could result in property damage or serious injury.

#### **Proper Installation and Handling:**

Because this is an electrically operated device, only properly-trained staff should install and/or repair this product. Use a proper sealant with all installations. *Note: Always install the 3/4" Viton gasket with all versions of Thermo-Flo with metric threads. The G threaded version will not seal unless the gasket is properly installed.* Never overtighten the sensor within the fitting, beyond a maximum of 80 inch-pounds torque. Always check for leaks prior to system start-up.

#### **Material Compatibility:**

The FT10 and GT10 series sensors are available in two different wetted materials. Models FT10-1\_\_5 and GT10-1\_\_5 are made of Polypropylene (PP) with Ryton tips. Models FT10-5\_\_5 and GT10-5\_\_5 are made of Polyvinylidene Fluoride (PVDF). Make sure that the model you have selected is compatible with the application liquid. To determine the chemical compatibility between the sensor and its application liquids, refer to an industry reference such as the Compass Corrosion Guide (available from Compass Publications, phone 858-589-9636).

#### **Wiring and Electrical:**

The supply voltage used to power the sensor should never exceed a maximum of 36 volts DC. Electrical wiring of the sensor should be performed in accordance with all applicable national, state, and local codes.

#### **Flammable, Explosive and Hazardous Applications:**

DO NOT USE THE FT10 OR GT10 SERIES GENERAL PURPOSE FLOW SWITCHES IN HAZARDOUS LOCATIONS.

#### **WARNING**

*The rating for the relay is 60 VA*

*Flowline's Thermo-Flo flow switches are not recommended for use with electrically charged application liquids. For most reliable operation, the liquid being measured may need to be electrically grounded.*

*Always install the 3/4" Viton gasket with all versions of the powered sensors with metric threads. The G threaded version will not seal unless the gasket is installed properly.*

## INTRODUCTION

### Step Three

#### **Technology:**

The thermal dispersion flow switch measures liquid or gas temperature to determine changes in flow velocity. As fluid flows across the sensing tips, the temperature is reduced proportionately as a function of the flow rate. When a temperature or velocity shift reaches the user defined set point, the switch changes state indicating the appropriate flow condition (flow or no-flow).

FLOWLINE's sophisticated electronics convert the temperature shift into a signal which indicates whether a flow or no-flow condition occurs. Depending on how the sensor is wired, this signal may be wired for normally open or normally closed circuits.

FLOWLINE's Thermo-Flo flow switches have no moving parts to clog or foul, making them suitable for a variety of applications, including non-coating and non-scaling liquids. The FT10 series directly measure mass flow and can operate over a broad range of liquids from 0.4 to 1.2 specific gravity, 1 to 300 cp. The GT10 series directly measure mass flow and can operate over a broad range of liquids from 0.4 to 1.2 specific gravity, 1 to 300 cp.

#### **Initialization Sequence for FT10 series:**

Powering up the FT10 is different in water and in air. When the flow switch is powered up while submersed, the FT10 will immediately indicate flow before switching to its correct state. When the flow switch is powered up while in air, the FT10 will immediately indicate no-flow before indicating its correct state. A time delay may be used to eliminate this initialization sequence. Flowline's thermal dispersion relay controllers feature a 0 to 60 second time delay for your convenience.

# INSTALLATION

## Step Four

The FT10 series flow switch must always be in contact with the liquid being measured. The GT10 series flow switch must never be submersed in liquid. Both flow switches feature a 3/4" NPT threads which will allow it to be used with various types of fittings. Be sure to check the insertion depth of the flow switch in the fitting after it is installed. See the diagram below for the recommended insertion depth.

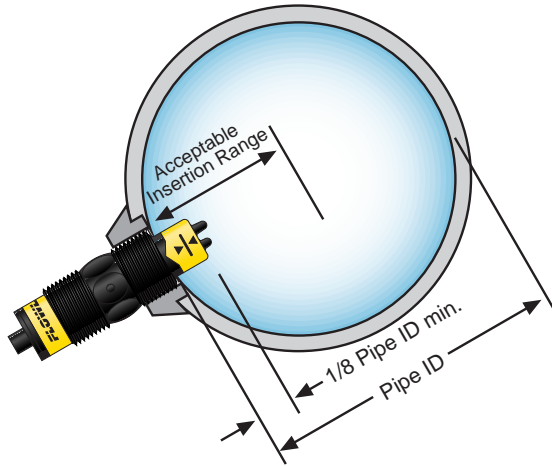

When using any type of fitting, the orientation as well as the insertion depth of the flow switch in the pipe is critical. See the diagram below for the recommended orientation depth.

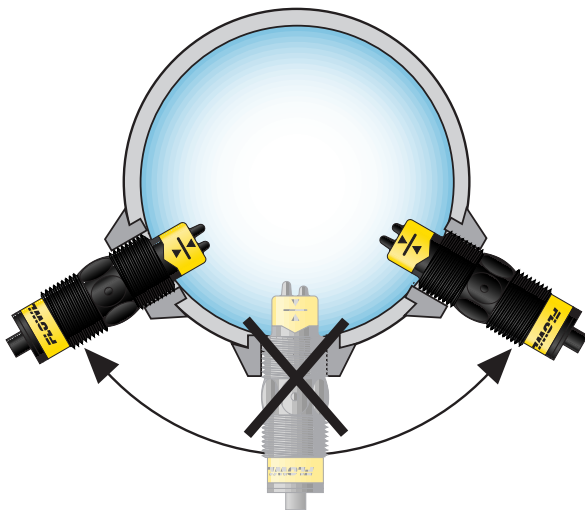

### ⚠ WARNING ⚠

The flow switch tips have a thin plastic wall which may be damaged if dropped or installed improperly.

The FT10 flow switch is designed for use in liquid. For best results, avoid installing the FT10 where bubbles are present or where the tips of the switch may be out of the liquid.

The GT10 flow switch is designed for use in gas applications. For best results, avoid installing the GT10 where it may be submersed in liquid.

Note: Always install the Viton gasket with all versions of the FT10-\_\_2\_\_. The G threaded version will not seal unless the gasket is properly installed.

# WIRING

## Step Five

### Supply Voltage:

The supply voltage to the Thermo-Flo flow switch should never exceed a maximum of 36 VDC. Use controllers or power supplies, with a minimum output of 12 VDC or a maximum output of 36 VDC.

### Required Cable Length:

Determine the length of cable required between the Thermo-Flo flow switch and its point of termination. Allow enough slack to ensure the easy installation, removal and/or maintenance of the sensor. The cable length may be extended up to a maximum of 1000 feet, using a well-insulated, 14 to 20 gauge shielded four conductor cable.

### Wire Stripping:

Using a 10 gauge wire stripper, carefully remove the outer layer of insulation from the last 1-1/4" of the sensor's cable. Unwrap and discard the exposed foil shield from around the signal wires, leaving the drain wire attached if desired. With a 20 gauge wire stripper, remove the last 1/4" of the colored insulation from the signal wires.

### Signal Output (Relay switching):

Allows the sensor to switch a small load on or off directly, using an internal relay rated below 60 VA. The NO/NC status is set by the polarity of the voltage feeding the red and black wires. The green wire is the common for the relay and the white wire is the NO or NC, depending on the polarity of red and black.

### Normally Open Wiring:

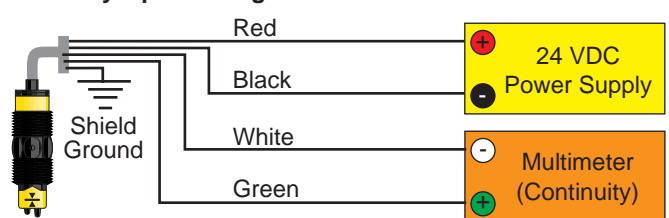

### Wiring to a Flowline Controller: LC30 Series Controller

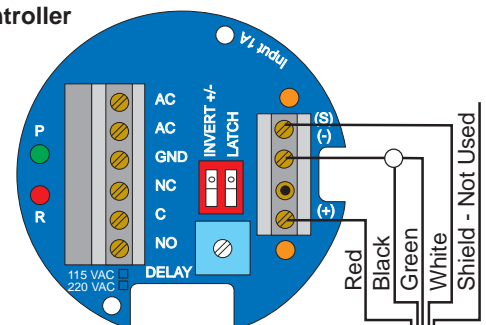

### LC80 Series Controller

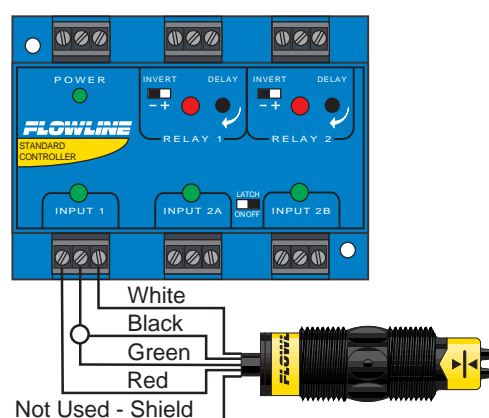

# WIRING

## Step Six

### Wiring the Relay Output:

The Thermo-Flo relay output can be wired as a dry contact to a VDC or VAC power source. Thermo-Flo does require 12 - 36 VDC power to operate the sensor and switch the relay. All illustrations below identify a Dry switch state as the normal position of the relay.

### Switching a Normally Open DC Load:

The Red wire connects to Positive (+) of the power supply and the Black wire connects to Negative (-). The LOAD can be attached to either the Green or White wires. Complete the circuit by either connecting the Green to (+) VDC power or White to (-) VDC power (see illustration below).

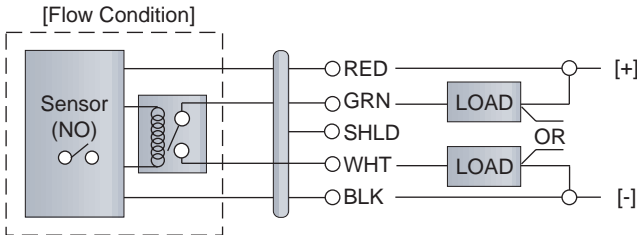

### Switching a Normally Closed DC Load:

The Black wire connects to Positive (+) of the power supply and the Red wire connects to Negative (-). The LOAD can be attached to either the Green or White wires. Complete the circuit by either connecting the Green to (+) VDC power or White to (-) VDC power (see illustration below).

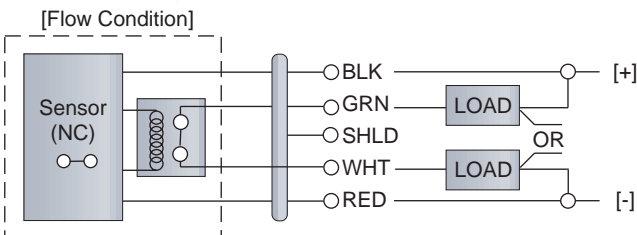

### Switching a Normally Open AC Load:

The Red wire connects to Positive (+) of the DC power supply and the Black wire connects to Negative (-). The LOAD can be attached to the Green wire and the Hot of the VAC power. Connect the White to the Neutral of the VAC power (see illustration below).

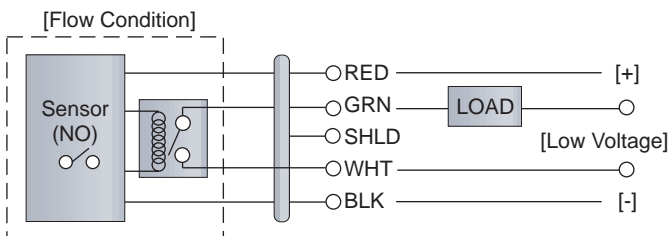

### Switching a Normally Closed AC Load:

The Black wire connects to Positive (+) of the DC power supply and the Red wire connects to Negative (-). The LOAD can be attached to the Green wire and the Hot of the VAC power. Connect the White to the Neutral of the VAC power (see illustration below).

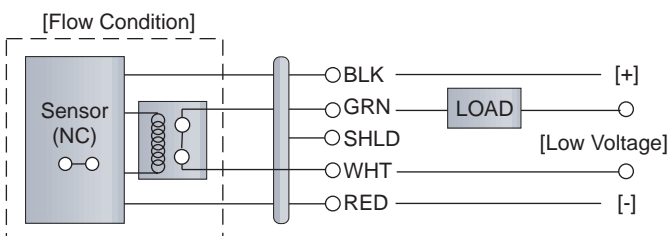

# WIRING

## Step Seven

### Wiring as a P-Channel or N-Channel output:

The Thermo-Flo can be substituted for either a P-Channel (PNP, sourcing) output or a N-Channel (NPN, sinking) output.

### Normally Open DC Load as a P-Channel Output:

To wire as a NO P-Channel output, follow the directions below. The Red wire connects to Positive (+) of the power supply and the Black wire connects to Negative (-). The Green wire is jumpered to the Red wire while the White wire is connected to the LOAD. Jumper the LOAD back to the Negative (-) to complete the circuit.

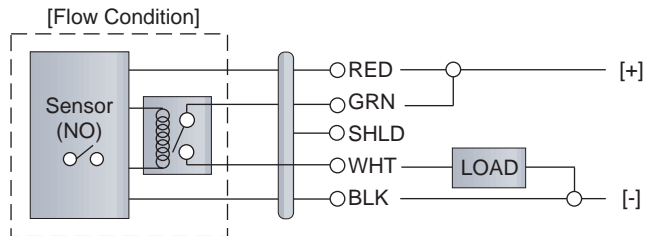

### Normally Closed DC Load as a P-Channel Output:

To wire as a NC P-Channel output, follow the directions below. The Black wire connects to Positive (+) of the power supply and the Red wire connects to Negative (-). The Green wire is jumpered to the Black wire while the White wire is connected to the LOAD. Jumper the LOAD back to the Negative (-) to complete the circuit.

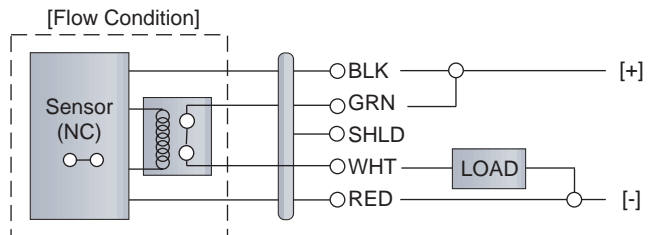

### Normally Open DC Load as a N-Channel Output:

To wire as a NO N-Channel output, follow the directions below. The Red wire connects to Positive (+) of the power supply and the Black wire connects to Negative (-). The White wire is jumpered to the Black wire while the Green wire is connected to the LOAD. Jumper the LOAD back to the Positive (+) to complete the circuit.

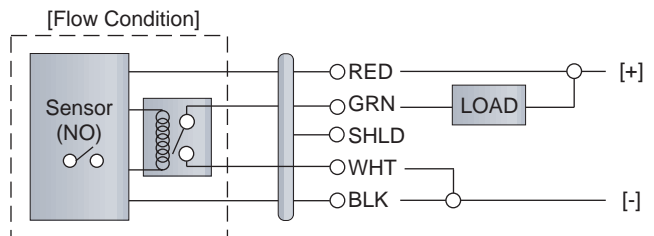

### Normally Closed DC Load as a N-Channel Output:

To wire as a NC N-Channel output, follow the directions below. The Black wire connects to Positive (+) of the power supply and the Red wire connects to Negative (-). The White wire is jumpered to the Red wire while the Green wire is connected to the LOAD. Jumper the LOAD back to the Positive (+) to complete the circuit.

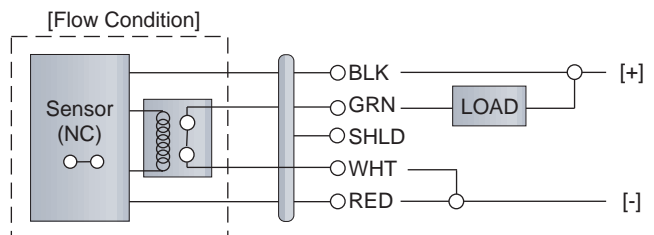

## CALIBRATION

### Step Eight

#### Set Points:

If the preset factory calibration is not adequate for your application, follow the calibration steps listed below.

*Note: the switch's internal LED will be on when the switch detects no-flow and will off when the switch detects flow.*

1. Install the fitting and flow switch as described in the Installation section of this manual. Turn the flow switch and controller power on and adjust the flow rate to the application setting. If the medium to be sensed is likely to be subject to high temperature variations, the flow switch should be set at the highest normal temperature likely to be encountered.
2. Locate the potentiometer knob at the top of the flow switch. The red LED is visible through the potentiometer. (If the LED is on, slowly adjust the potentiometer counterclockwise, with a small flat head screwdriver until the LED turns off.) The adjustment is a single turn 270° potentiometer. The initial response time of the flow switch after adjustment is 1 to 10 seconds. Adjust the potentiometer in slow increments and wait for the response.

If the LED is off, slowly adjust the potentiometer clockwise until the light turns on. Then turn the potentiometer counterclockwise to bring the LED off at a reliable setting. Remember, adjust the potentiometer in slow increments and wait for the response.

3. Verify that the new calibration is correct by lowering the system flow rate below the set point and check to see that the red LED turns on. Then increase the flow rate above the set point and verify that the red LED turns off accordingly.

Potentiometer Knob

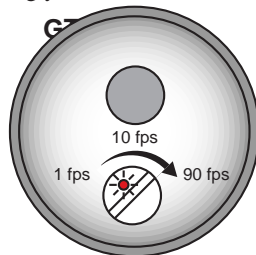
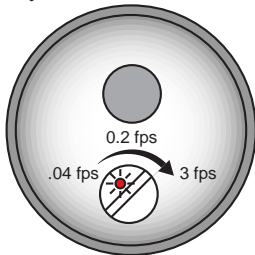

## MAINTENANCE

### Step Nine

#### General:

The Thermo-Flo flow switch requires no periodic maintenance except to clean off any deposits or scaling from the sensor tip as necessary. It is the responsibility of the user to determine the appropriate maintenance schedule, based on the specific characteristics of the application liquids.

#### Cleaning Procedure:

1. **Power:** Make Sure that all power to the sensor, controller and/or power supply is completely disconnected.
2. **Sensor Removal:** *Make sure that the flow is off and the pressure is down prior to removing the Thermo-Flo.* Carefully, remove the sensor from the installation. Replace the sensor with a 3/4" NPT plug to insure that liquid does not leak out during this procedure. *Do not re-install the Thermo-Flo if the threads are damaged.*
3. **Cleaning the Sensor:** Use a soft bristle brush and mild detergent, carefully wash the Thermo-Flo flow switch. Do not use harsh abrasives such as steel wool or sandpaper, which might damage the surface sensor. Do not use incompatible solvents which may damage the sensor's PP/Ryton or PVDF plastic body.
4. **Sensor Installation:** Follow the appropriate steps of installation as outlined in the installation section of this manual.

#### Testing the installation:

1. **Power:** Turn on power to the controller and/or power supply.
2. **Immersing the switch:** Immerse the sensing tip in its application liquid, by filling the tank up to the switches point of actuation. An alternate method of immersing the switch during preliminary testing is to hold a cup filled with application liquid up to the switch's tip.
3. **Test:** With the switch being fluctuated between wet and dry states, the switch indicator light in the controller should turn on and off. If the controller doesn't have an input indicator, use a voltmeter or ammeter to ensure that the switch produces the correct signal.
4. **Point of actuation:** Observe the point at which the rising or falling fluid level causes the switch to change state, and adjust the installation of the switch if necessary.